

*Emhætte
Brugsvejledning*

4204

www.jgnordic.com

SILVERLINE®



Kontaktoplysninger

Jilmas Group Nordic ApS Hi Park 399 7400 Herning Denmark
Tel.: +45 70104014 - Fax: +45 70131389

Presentation of product

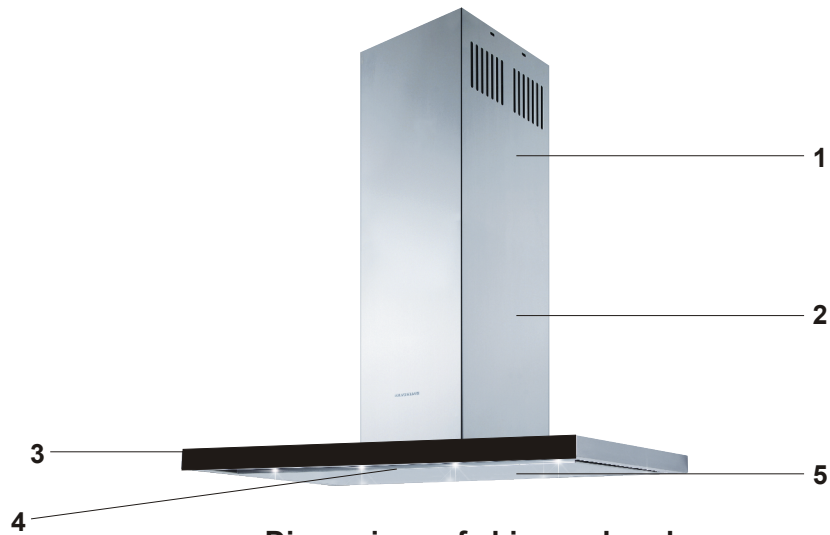

Dimensions of chimney hood

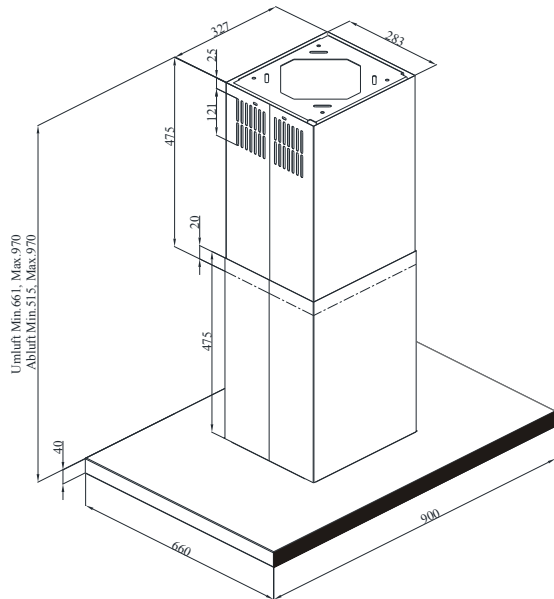

- 1-Internal chimney
- 2-External chimney
- 3-Control panel
- 4-Lighting
- 5-Split extraction plate

	Check electric connection (Voltage of the electric network should be between 220-240V, cooker hood should be connected to grounded plug.)	Check motor switch (Motor switch should be at on position)	Check lamp switch (Lamp switch should be at on position)	Check aluminum filter (Aluminum Cassette Filter should be washed once a month at normal conditions.)	Check lamps (Lamps should be firm.)	Check outlet (Outlet should be open)	Check Carbon Filter (Carbon filter should be replaced with a new one each 2-3 months at the models with Carbon Filter at normal conditions)
Cooker-hood does not work	X	X					
Illumination Lamp does not work	X		X		X		
Cooker-hoods air suction is weak				X		X	X
Cooker-hood does not direct air out (at places without chimney)				X			X

If the product does not work:

Before you contact the technical service:

Make sure that the product is plugged in and the electric fuse of the electric wiring is running. Do not take any action that will damage the product. Before you contact with technical service, check your cooker hood according to Table 1. If the problem goes on, contact the seller or the most authorized service.

TECHNICAL SPECIFICATIONS

Feeding Voltage	220-240 V 50Hz
Motor Isolation Class	F
Isolation Class	CLASS I

In order to use the cooker hood efficiently;

- *Use ducts of 150/120mm diameter and as few bends as possible when you make the chimney connection.
- *Pay attention to aluminum filters' cleaning periods and changing periods of carbon filters.
- *Use the product at middle speed if high suction power is not necessary.
- * In order to ensure that ventilation occurs correctly, windows of the kitchen should be kept closed.

WARNINGS AND SAFETY PRECAUTIONS

- *This product is designed for usage at home.
- *Your products usage voltage is 220-240 Volts~50Hz
- *Grounded plug is used at your product's electric network cable. This cable should definitely be plugged in a grounded socket.
- *All electrical networks should be set by a qualified electrician.
- *Installation applied by unauthorized people may cause the product to operate at low performance, damage of the product and accidents.
- *Power supply cable should not be exposed to press or smash during montage. Network cordon should not be placed near the cookers; it may cause fire if it melts.
- *Do not plug into the socket before installation of the product is completed.
- *Keep the plug at a reachable place so that you can unplug it in case of any danger.
- *Do not touch the lamps when they are on for long time. Lamps may hurt your hand as they will be hot.
- *Kitchen cooker hoods are designed for usage during normal and home-style cooking. If it is used for other purposes, failure risk occurs and it will be out of warranty.
- *Follow applicable rules and directions for passing out outlet air. (This warning is not valid for usage without chimney.)
- *Flaming foods should not be cooked under the product.
- *Start your product after you put pot, fry-pan etc. on the hob. Otherwise high temperature may cause some parts of your product to get deformed.
- *Before you take pot, fry-pan etc. from the hob, put their lids on.
- *Do not leave hot oil on the hob. Pots that have hot oil in them may cause self-ignition.
- *Pay attention to curtains and covers during cooking of meals like frying because oil may flare up.
- *Make sure that filters are changed in convenience. Filters that are not changed at appropriate time has risk of causing fire due to oil that will be gathered on them.
- *Do not use filter materials that are not flame resistant instead of filter.
- *Do not operate your product without aluminum filter; do not remove filters when the product is on.
- *In case of flame, cut power of the product and the cooking appliances. (Cut power of the product by plugging it off the socket).
- *Your product may cause fire risk if cleaning is not applied periodically.
- *Cut power of the product before maintenance process. (Cut power of the device by unplugging it)

*When chimney hood and the appliances working with energy other than electricity are operated at the same time, negative pressure in the room should not be more than 4 Pa (4 x 10⁻⁵ bar)

*If there is an appliance working with fuel or gaseous fuel at the same place with your hood, this appliance's exhaust should be isolated from its volume totally and the appliance should be hermetic type.

*When chimney connection is applied to your product, use ducts of 150mm or 120mm diameter. Duct connection should be as short as possible and should include few bends.

*Keep package materials away from children as they may be dangerous for them.

Warning about Transportation and Carriage

- *All the materials used at package of your product are suitable for recycling.
- *Please comply with the signs on the product's box during transportation.
- *Hold the holders placed at sides of the box in order to carry your product. If you need transportation;
- *Keep the original box.
- *Carry your product in its original box; comply with the carrying signs on the product's box.
- If there is no original package;
- *Do not put heavy material on the chimney hood.
- *Keep the external surface from bash.
- *Pack your product to avoid damages.

Installation, taking off your product from its package:

- *Check if there is any deformation on your product.
- *Transportation damages and failures should immediately be reported to the transportation responsible.
- *If you notice any damage please report to the seller.
- *Do not allow children to play with packing material!!!

*Be sure that your child does not play with the product. Do not allow kids to use your product.

*If power supply cable is damaged, this cable should be changed by its producer or its service agency or a personnel who is a specialist at the same level in order to prevent a dangerous situation.



*In case of flame, cut power of the cooker hood and the cooking appliances, cover the flame. Never use water in order to extinguish it.

Use "MAX 6 A" fuse at cooker hood installment for your security.

Usage of 5 Speed Digital Control

Usage

Remove protective folio on the inox product after installation.

Speed Selection The product has 5 speeds of ventilation level. One of 1,2,3...9 speeds is selected in accordance with steam of cooking or fry. Motor is started pressing  control button on the front panel. Speed is increased pressing  button, and decreased by pressing  button. Automatic timer (TIMER) is available at the models with electronic remote control.

Timer

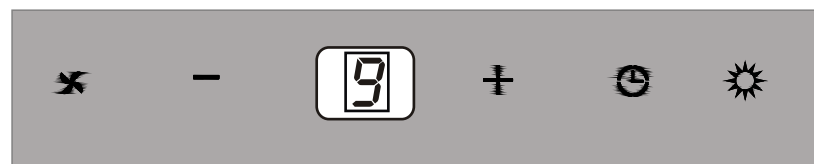

When pressed to  button more than 2 seconds, timer function will be activated for 15 minutes and timer sign will appear on screen. Motor will stop automatically after 15 minutes.



Illumination

The product has 2 lamps and one lamp button to operate illumination. Press lamp button in order to start illumination.

Cleaning Periods of the Aluminum Filters:

Filters should be cleaned when "C" signal appears on Display or (according to usage) each 2-3 weeks. In order to remove "C" signal, after the filters are cleaned and replaced to their place, press  button more than 3 seconds (when the product is at off position). Letter "E" will appear on Display and the product will operate as normal. If you would like to continue using the product without deleting "C" signal, when you press the  button active speed will appear for 1 second, then "C" signal will appear once more and the motor will continue operating.

NOTE: "C" signal will appear after usage of the product for 60 hours.

NOTE: If your product has dimmer function please pay attention to the explanation stated below.

Changing Brightness of the Lamp (Dimmer):

When the lamp is on, lamp's brightness starts to change continuously if you keep lamp button pressed. When you get the brightness level that you wish and stop pressing the button, brightness that is set will be recorded, and the product will start with the same brightness during next usage. When you press the lamp button 2 times consecutively, the lamp will be on at the highest brightness level. The lamp will always start at the brightness level that is set during last usage.



Picture 16

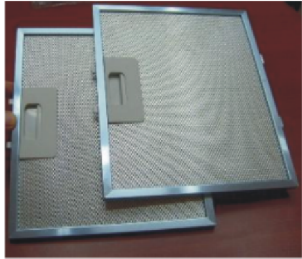

Dishwasher safe aluminum cassette filter.

Picture 17

MAINTENANCE

*Disconnect electricity connection before maintenance and cleaning process.

*Aluminum cassette filter holds the dust and the oil in the air.

*Metal filter should be washed once in a month with hot and soaped water or, if possible, at dishwasher (60C).

*Take off aluminum cassette filter pressing on springy latches on end point. After cleaning, do not replace before it dries.

*Outer surface of the cooker hood should be wiped with a wet cloth that is wetted with water or alcohol.

*Please avoid contact of electronic parts with water or similar materials.

*Using Inox cleaning and maintenance products available in the market will help your product to perform longer.

Warning: Aluminum filters may be washed in the dishwasher. Color of aluminum filters may change after several washings. This is normal and it is not necessary to change the filters.

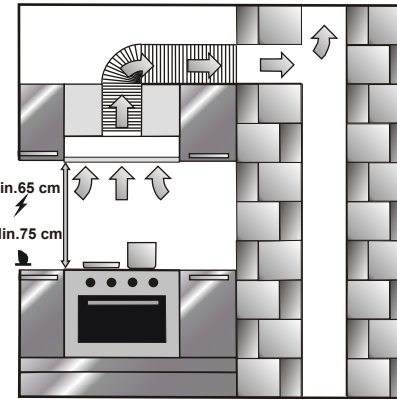

Figure 2

Place of the Product:

After installation of your product, distance between range hood and electrical hob should be at least 65 cm and gas hobs at least 75cm.(Figure 2)

Installation: Taking off the product from its box

- * Please check if there is any damage or not on product.
- * Transport damages should be reported to transporter immediately.
- * Damages and defects should be reported also seller.
- * Do not allow children to play with packing material.

Efficient Ventilation

In order to ensure correct ventilation, keep your kitchen windows closed.

IMPORTANT NOTE

Please pay attention when the product is operated at the same time with a product which operates using air and fuel (for instance; heater, water heater etc. which operates using gas, diesel fuel, coal or wood), since cooker hood may affect burning negatively as it directs the air out.

This warning is not valid for usage without chimney.

MOUNTING ISLAND CHIMNEY HOOD

Please follow below instructions.

Installation of ceiling connection plate :

Front sticker (figure 3) on ceiling connection plate and control panel of chimney hood should have the same direction.

- 1) Drill 10mm holes from A,B,C,D points.
- 2) Drive 10mm wall plugs in to A,B,C,D holes.
- 3) Fix ceiling connection plate to ceiling by using 4 screws (5,5 x 45). Wall plugs, screws and ceiling connection plate are given with chimney hood. Picture 3

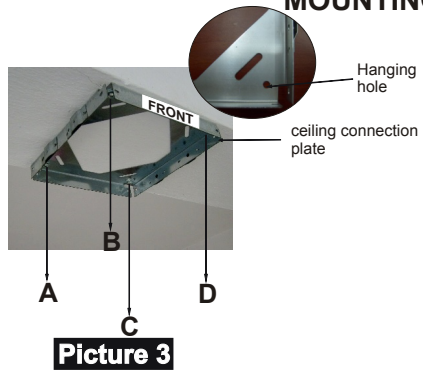

Picture 3

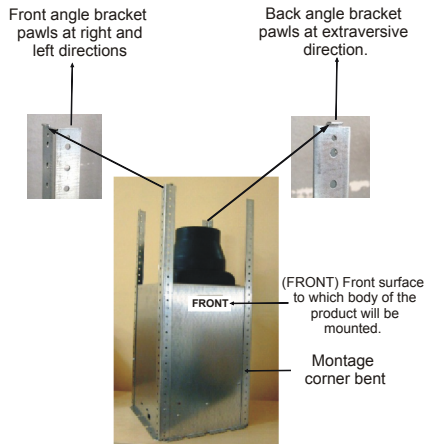

Picture 4

Installation of cornerpieces:

Front sticker (picture 4) shows where front side of chimney hood should be installed. Front cornerpieces should be left and right directions. Back cornerpieces should be extroverted. Screw 4 cornerpieces to motor block. Hanging bar should have same directions with ceiling connection plate. Regulating the length of chimney hood with these cornerpieces. Picture 4

Installation of chimneys to motor cabinet:

Please put internal chimney in external chimney. For temporary connection between chimneys please use a screw on motor cabinet. (So chimneys won't drop while you install motor cabinet to ceiling connection plate.) Mount the chimneys on this screw. (Screw holes of internal chimney should befit the side of motor cabinet.) Picture 5

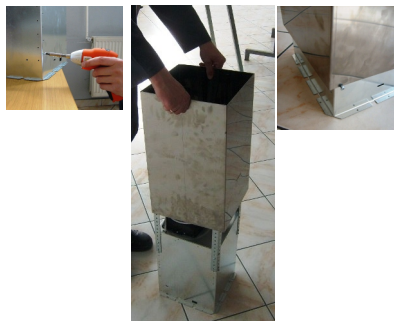

Picture 5

Changing Aluminum Casette Carbon Filter.

To remove, pull carbon filter towards yourself from the ratchets on top. Figure 4a

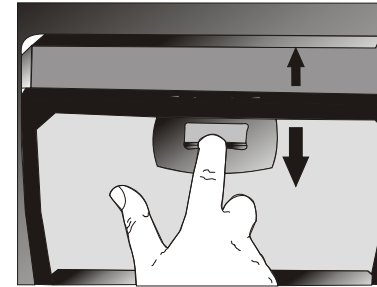
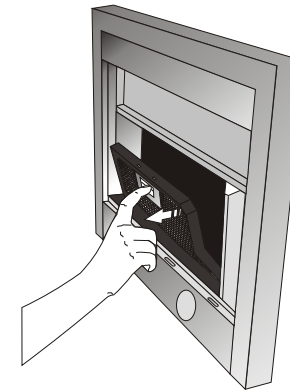

Figure 4a



Replacing Lamps

Unplug power cord of your cooker hood.

1W LED LAMBA Figure 5

- *Open the split extraction plate/glass.
- *Take off the aluminium cassette filter. (There are on the left and right back edges covers which you can use for changing the lamps on the edges. Take this covers off)
- *Disconnect cables of LED lights.
- *Push onto light to remove them.
- *Remove tape between lamp and product body.
- *Remove protective tape of new lamp before placing

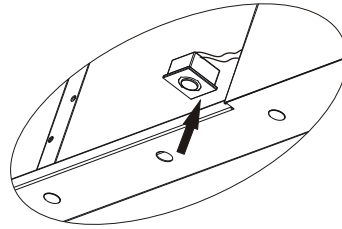

Figure 5

Functions of the Product

Your hood is compatible for use with our without chimney.

Usage with chimney

The product should be connected to a chimney that will direct the air out during usage with chimney. In order to achieve best performance, pay attention that the duct system follows the shortest way for connection to the chimney. Your product is produced as it will be appropriate for usage with chimney.

Attention!!!

Outlet of the product should not be connected to air canals that have other smoke as well.

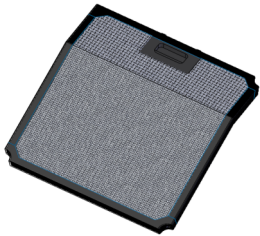

Figure 15

Active Carbon Filter

Carbon filters are used for filtering air and making air recycle where no wall air outlet is available. You may purchase carbon filters via authorized dealers and after sales services. (Picture 15)

Replacing Carbon Filters

Unplug product's power cord before changing carbon filter.

Carbon filters should be replaced in every 3-5 months as product is operated in kitchens with no air outlet.

You should use oil (aluminum cassette) filter all the times with our without carbon filter.

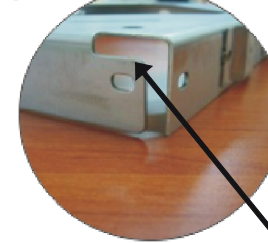

Picture 6

Installation bracket channels on ceiling mounting plate

Placing Motor Cabin to Hanging Bar

Place fixed hanging sticks on hanging bar through the channels. Fix parts together via 3,5x9,5 screws Picture 6



Picture 7

Installing Aluminum Flexible Pipe

Connect aluminum flexible pipe to outlets on the product and kitchen wall. Ensure connection will not lose while your product is operated on maximum airflow level (Picture 7).

Avoid multiple folds and angles as they may negatively affect air suction capacity.

Picture 8



Correct

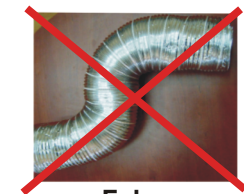

False

Picture 8

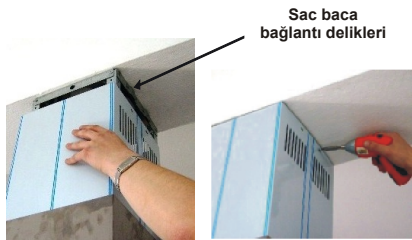

Sac baca bağlantı delikleri

Fixing Internal Chimney

Pull internal chimney up, align holes and fix by 3,5x9,5 nickel coated screws as shown in Picture 9.

Picture 9



Picture 10

Removing split extraction plate

To remove split extraction plate, pull it down holding left and right upper points. Picture 10



Hanging Hook

Fixing Motor Cabin on Product Body

Place hanging hooks on product body onto channels on motor cabin. Fix them together with 3,5x9,5 screws (Picture 11-12)



Hanging hook channel on motor cabin

Picture 11



Picture 12